

- Series 614 & 605 PGA carrier sockets offer 4 receptacle styles.
- Many combinations of receptacles and clips to cover all applications.
- Hi-Temp PCT polyester insulator material suitable for all forms of soldering.
- Carrier sockets provide a convenient way of loading groups of receptacles onto a PC board.

**APPLICATION OF
PGA SOCKET CARRIERS**

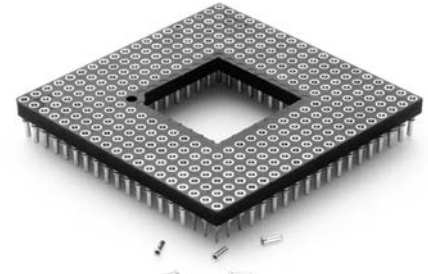

**LOW PROFILE
SERIES 614...001, 002, 003**

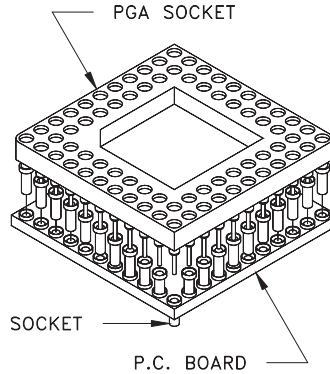
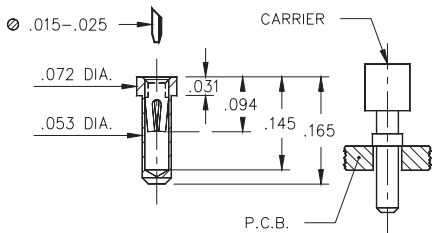

**MINIATURE
SERIES 614...007**

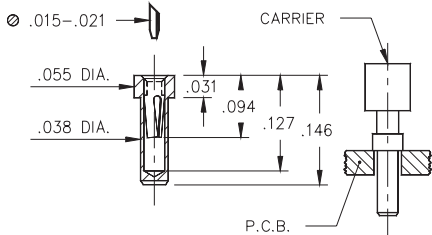

**LOWEST PROFILE
SERIES 614...012**

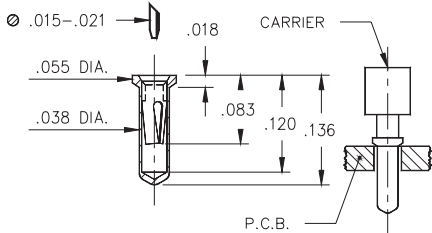

**REDUCED BARREL
SERIES 605...048**

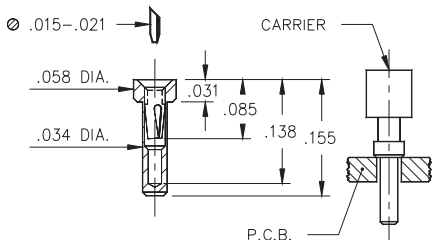

Ordering Information

1. Select receptacle type at left in combination with receptacle chart below to determine series prefix & suffix numbers.
2. Specify 2-digit plating code from chart at bottom of page
3. Locate footprint pattern from pages 107 to 111, the middle 8 digits of the part number will be located under the pattern.

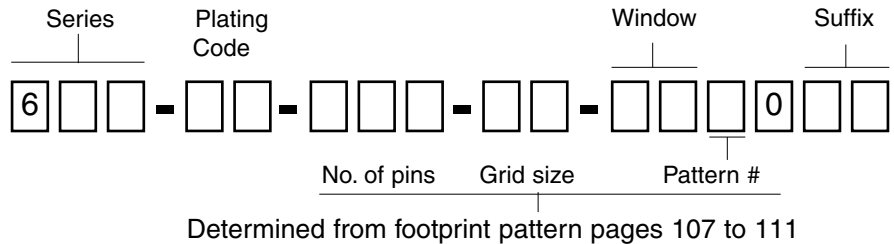

EXAMPLE OF COMPLETE PART NUMBER:
614-43-068-11-061001

This is a 68 pin (11x11 grid) insulator with a .6" square window and fitted with low profile receptacles. Pin sleeve is tin plated, inner contacts are Mill-Max #32 and are plated 30µ" gold.

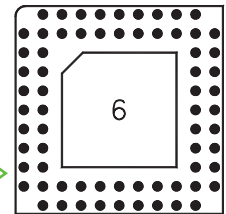

Suffix

Receptacle/ Clip Chart

01	Low Profile Mill-Max #32 clip, standard low force, recommended for devices with less than 150 pins. See page 208 for details.
02	Low Profile Mill-Max #35 clip, ultra low force, recommended for devices with more than 150 pins, but less than 250 pins. See page 209 for details.
03	Low Profile Mill-Max #43 clip, "ultra lite", recommended for devices with more than 250 pins. See page 209 for details.
07	Miniature Mill-Max #21 clip, standard low force. See page 206 for details.
12	Lowest Profile Mill-Max #21 clip, standard low force. See page 206 for details.
48	Reduced Barrel Mill-Max #21 clip, standard low force. See page 206 for details.

SPECIFY PLATING CODE XX=	13	93	43
Sleeve (Pin)	10µ" Au	200µ" Sn/Pb	200µ" Sn
Contact (Clip)	30µ" Au	30µ" Au	30µ" Au